

Article number: 12704000040120

Description: KLEE-coil 704 000 040.120

M4 Unhardened, zinc-pl. & chr. yellow

Measures

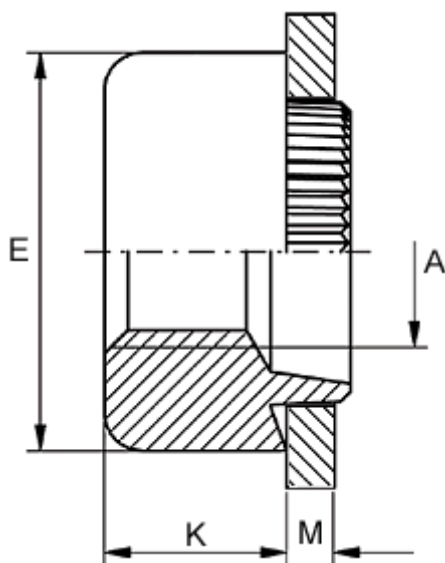

Female thread A	= M4
Height K	= 4.0
Outer diameter E	= 10.0
Plate thickness	= 0.9 to 1.0
Recommended bore diameter for extreme load	= 7.0
Recommended bore diameter for normal use	= 7.0